

WARNING: Moving parts, beware of entrapment areas

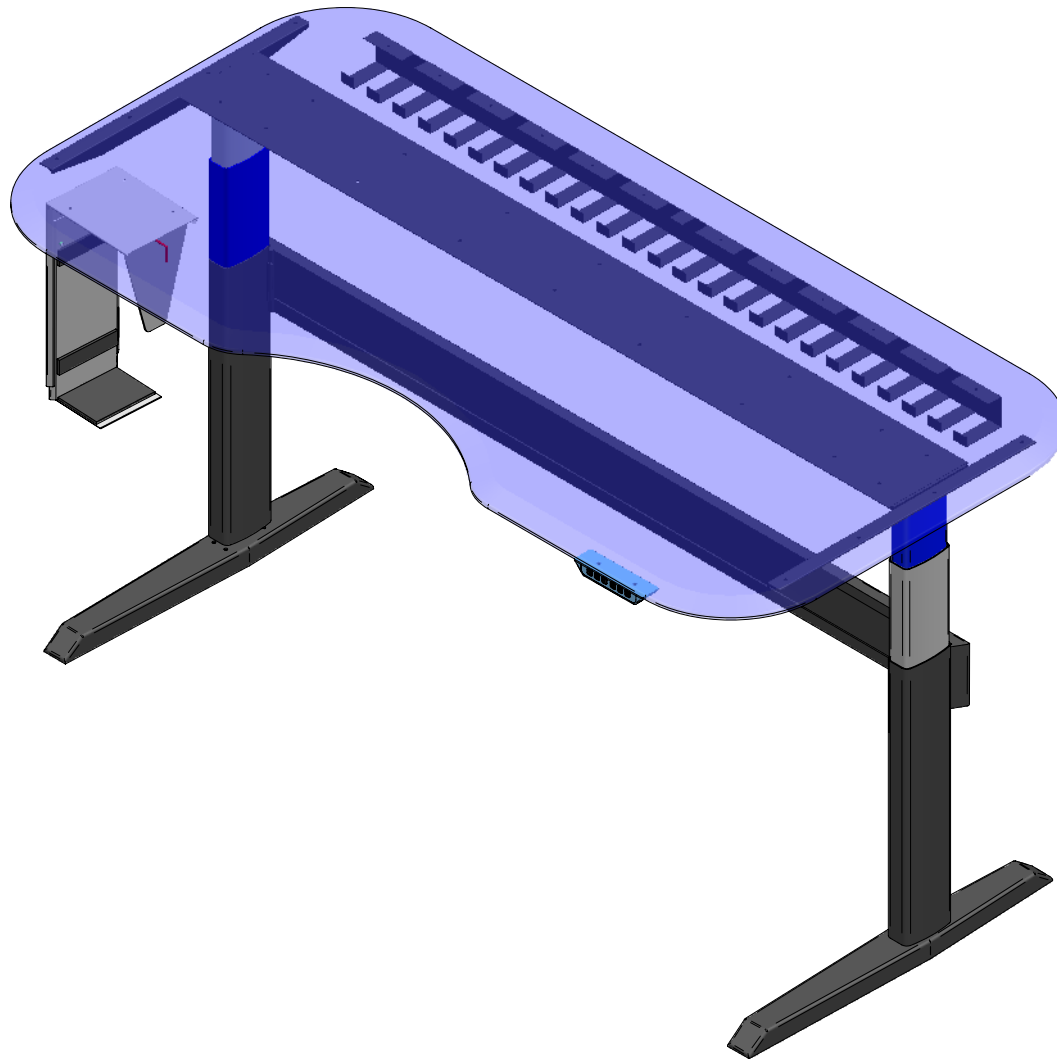

motiondesk2-DL4

675mm electric adjustment
650mm to 1325mm (from floor level)
140kg total lift capacity
15 seconds from sit to stand
Optional multiple Memory positions
Optional cable tray
Optional CPU Holder
Optional Anti-Collision
Available to suit all desk sizes
2 year warranty on electrics
10 year warranty on frame

© Copyright all rights reserved.

This drawing is the property of Ergomotion Pty Ltd. It may not be copied in whole or part nor can it be used for the manufacture of any equipment described without written permission of Ergomotion.

Customer:

Date:

ergomotion

PO Box 234, East Bentleigh, VIC, 3165
+61 3 95791454

TITLE: motiondesk2-DL4

Designed by Guy Topolansky