

WARNING: Moving parts, beware of entrapment areas

motiondesk3-DL6

650mm electric adjustment
600mm to 1250mm (from floor level)
200kg total lift capacity
15 seconds from sit to stand
Optional multiple Memory positions
Optional cable tray
Optional CPU Holder
Optional Anti-Collision
Available to suit all desk sizes
2 year warranty on electrics
10 year warranty on frame

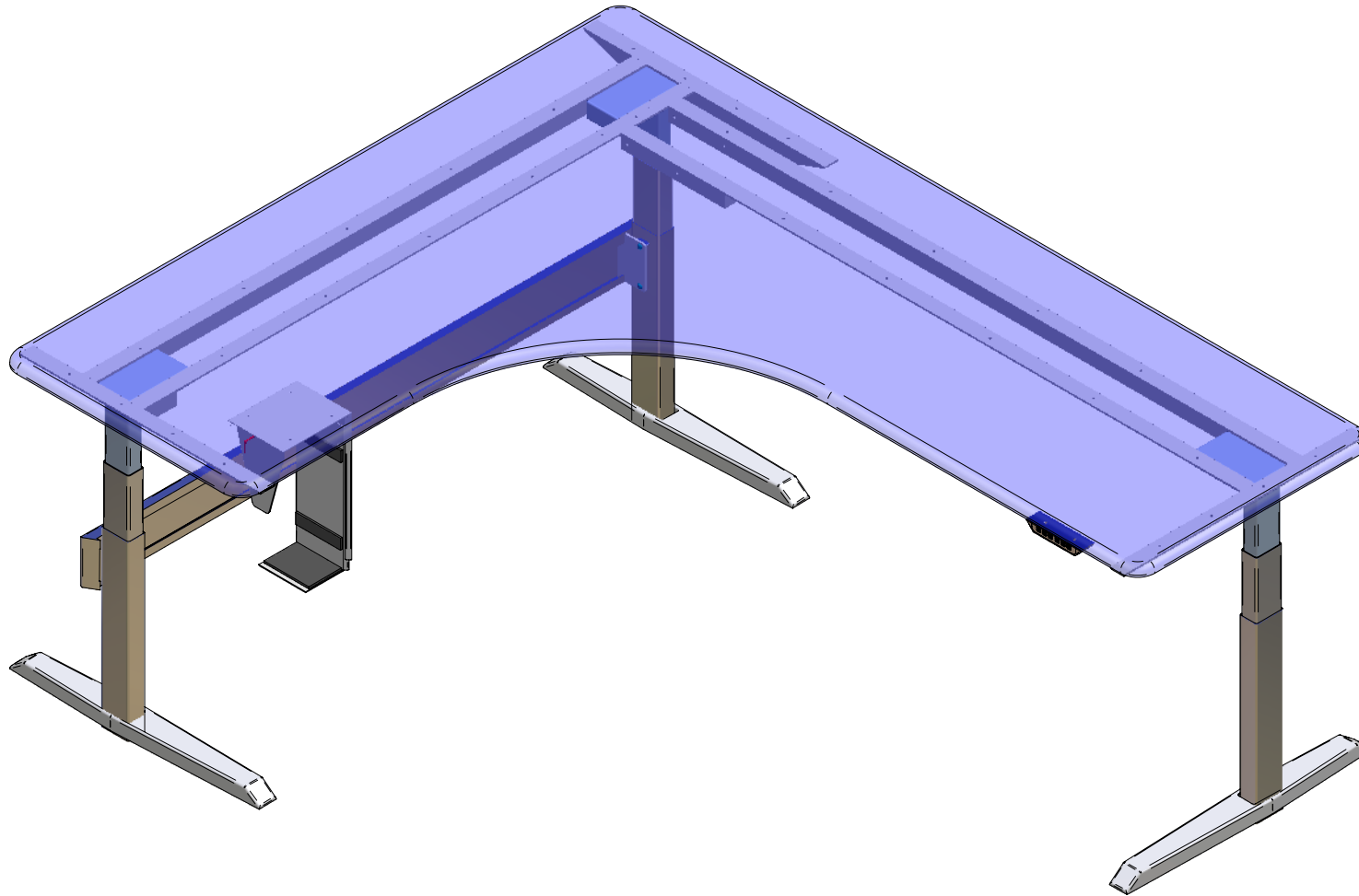

© Copyright all rights reserved.
This drawing is the property of Ergomotion Pty Ltd. It may not be copied in whole or part nor can it be used for the manufacture of any equipment described without written permission of Ergomotion.

Customer:

Date:

ergomotion

PO Box 234, East Bentleigh, VIC, 3165
+61 3 95791454

TITLE: motiondesk3-DL6

Designed by Guy Topolansky