

**WARNING:** Moving parts, beware of entrapment areas

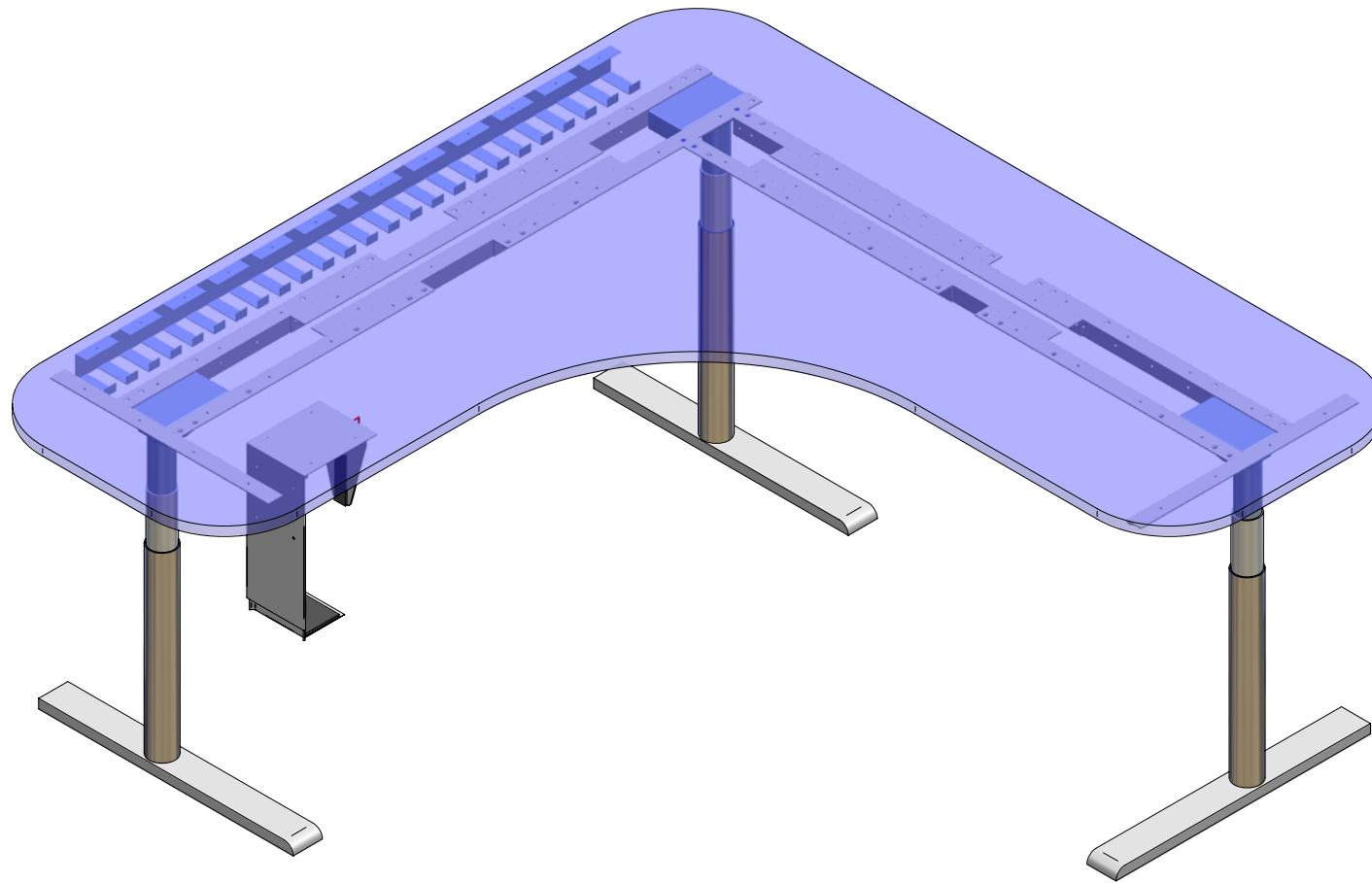

### **motiondesk3-DL11**

635mm electric adjustment  
600mm to 1250mm (from floor level)  
200kg total lift capacity  
15 seconds from sit to stand  
Optional multiple Memory positions  
Optional cable tray  
Optional CPU Holder  
Optional Anti-Collision  
Standard frame suits desk 1.5m-2.2m in length  
Custom frames available to suit all desk sizes  
2 year warranty on electrics  
10 year warranty on frame

© Copyright all rights reserved.

This drawing is the property of Ergomotion Pty Ltd. It may not be copied in whole or part nor can it be used for the manufacture of any equipment described without written permission of Ergomotion.

Customer:

Date:

**ergomotion**

PO Box 234, East Bentleigh, VIC, 3165  
+61 3 95791454

**TITLE: motiondesk3-DL11**

Designed by Guy Topolansky